

## PROFILES DE COFFRE DE VOLET ROULANT

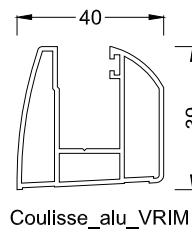

## ACCESSOIRES VOILET ROULANT

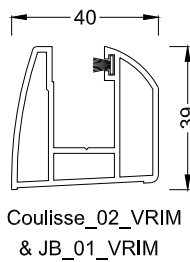
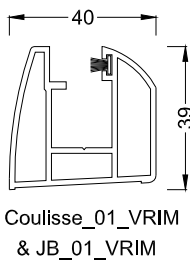
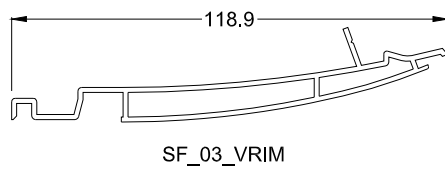
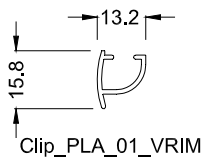
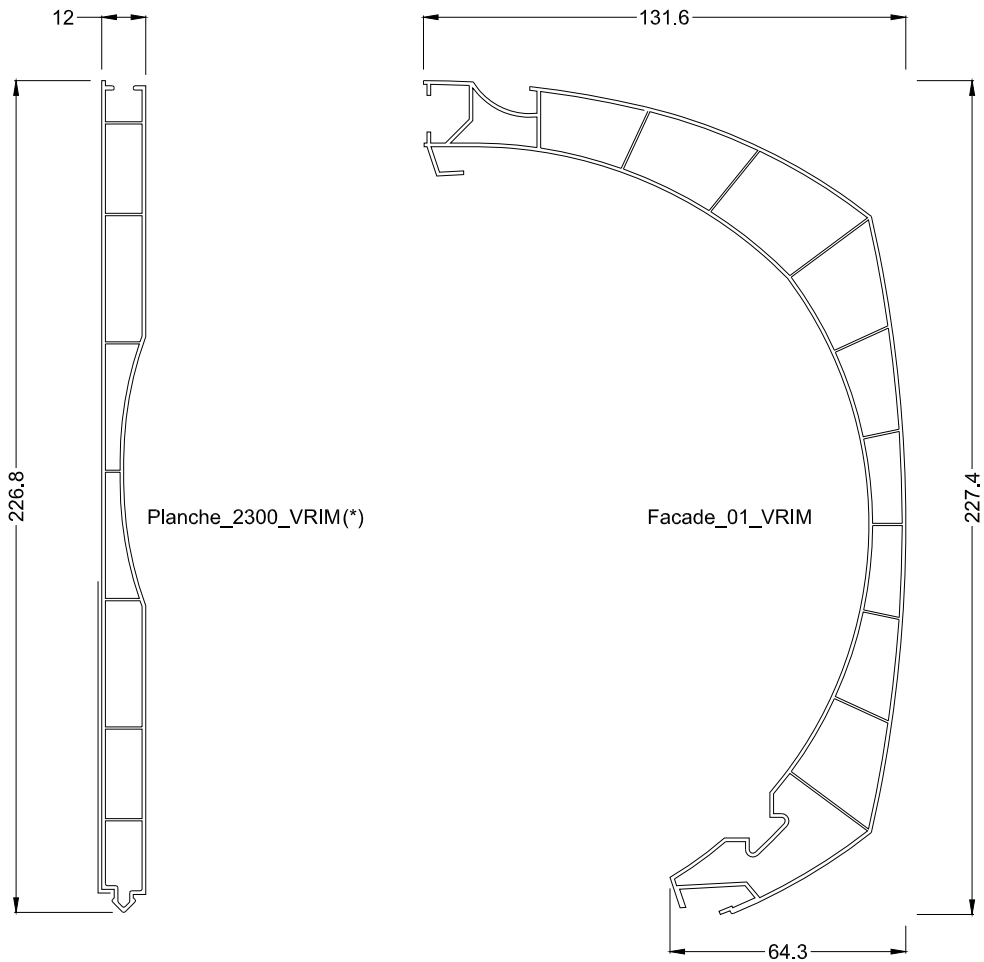
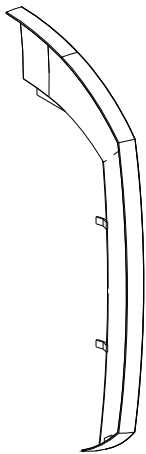

Enjoliveur d'embout de coffre  
(gauche ENBLG & droit ENBLD)

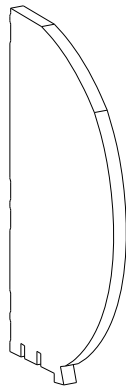

Isolant d'embout de coffre  
(gauche ISOEMB\_G & droit ISOEMB\_D)

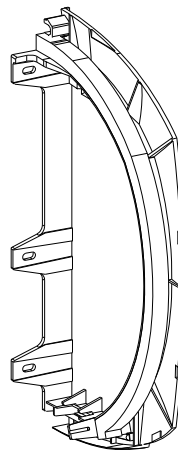

Embout de coffre  
(gauche EC\_G & droit EC\_D)

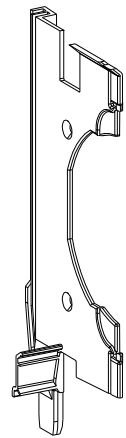

Flasque plastique  
(gauche FP\_G & droit FP\_D)

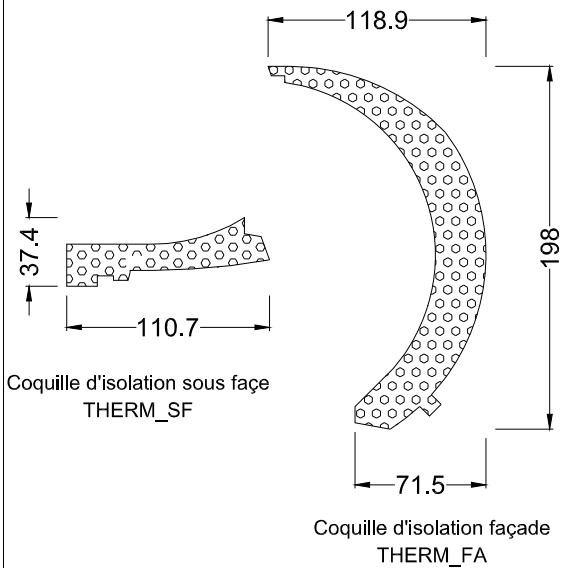

Coquille d'isolation sous façade  
THERM\_SF

Coquille d'isolation façade  
THERM\_FA



Clip de façade intérieure  
CI\_01



Clip de façade extérieure  
CE\_01



Palier manchon  
PMPC



Butée  
BLFBL

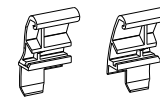

Tulipe  
(gauche TULIG & droit TULID)



Mousse d'étanchéité façade  
MOUSSE\_FA



Bloc guide  
BLGCL

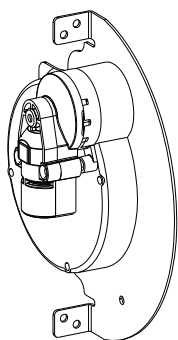

Ensemble flasque tôle + treuil  
(gauche FTT\_G & droit FTT\_D)

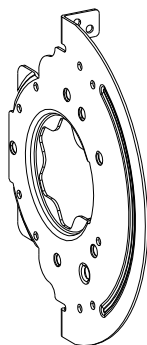

Flasque tôle électrique  
FTE

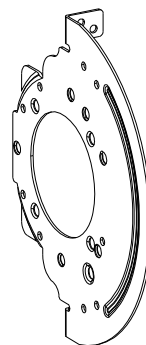

Flasque tôle manoeuvre de secours  
FTCSI

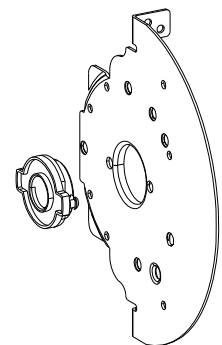

Flasque tôle opposé manoeuvre  
FTOM

## ECLATE DU COFFRE VRIM

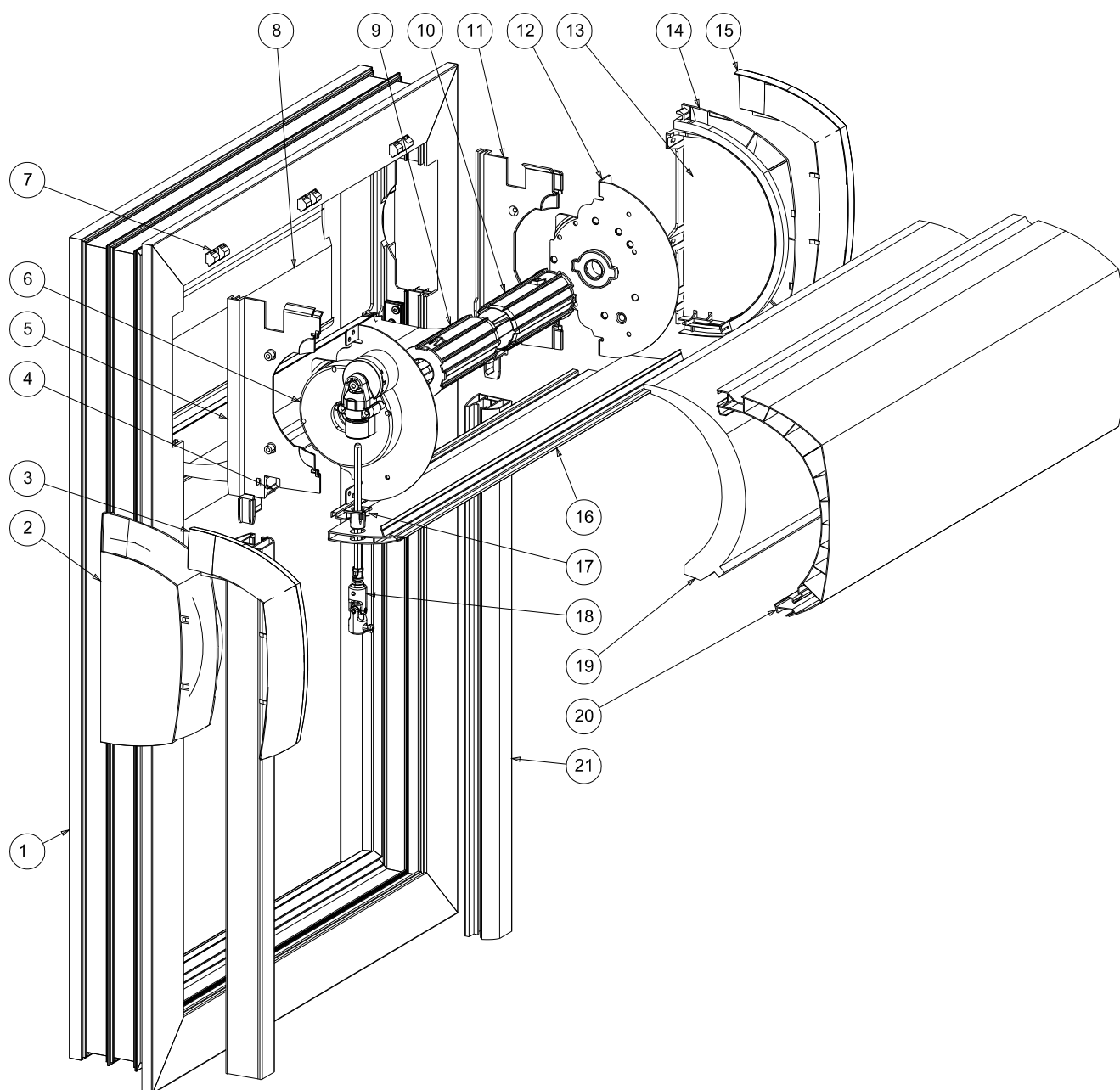

11	FP_D	Flasque plastique droit
10	EMAOM	Embout coté opposé à la manoeuvre
9	EMBAM	Embout coté manoeuvre
8	Planche_2300_VRIM	Façade extérieure
7	CI_01	Clip de façade intérieure
6	FTT_G	Flasque tôle TSL gauche
5	FP_G	Flasque plastique gauche
4	TULIG	Tulipe gauche
3	ENBLG	Enjoliveur gauche
2	EC_G	Embout de coffre gauche
1	DOR100	Dormant menuiserie
REP	REFERENCE	DESIGNATION

21	Coulisse_01_VRIM	Coulisse PVC
20	Façade_01_VRIM	Façade
19	THERM_FA	Coquille d'isolation façade
18	BLGCL	Bloc guide
17	PMPC	Palier manchon
16	SF_03_VRIM	Sous face alu
15	ENBLD	Enjoliveur droit
14	EC_D	Embout de coffre droit
13	ISOEMB_D	Isolant embout de coffre
12	FTOM	Flasque tôle opposé manoeuvre
REP	REFERENCE	DESIGNATION

# COUPES VRIM DOUBLAGE DE 100 mm

mousse adhésive une face  
positionnée sur la façade  
avant assemblage  
réf. 152GM50

